

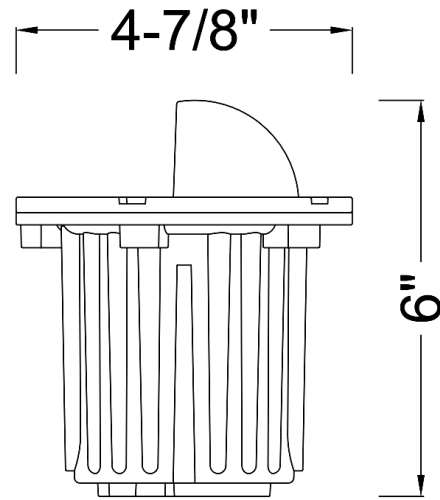

DIMENSIONS:



WL-707-FGBZ

SOLID BRASS WELL LIGHTS WITH DIRECTIONAL LAMP BRACKET

ELECTRICAL SPECIFICATIONS:

- Voltage: 12VAC/DC
- Wattage: 5W
- Efficacy: 80LM/W

HOUSING SPECIFICATIONS:

- Solid Brass Covers & Fiber Glass Housing
- Antique Bronze Finish
- Silicon-filled wire nuts
- 3FT. SPT-2 18AWG Lead Wire
- IP rating: IP67, Suitable for wet Locations

CERTIFICATIONS:



MODEL	WATTS	VOLTAGE	LUMENS	COLOR TEMP
WL-707-FGBZ	5W	12VAC/DC	400LM	3000K

ACCESSORIES INCLUDED:



LIGHTING SPECIFICATIONS:

- Light Source: MR16 Lamp Included (WESTGATE Part Number: MR16-400L-30K-D)
- Lens: Flat Temp. Glass Lens
- Total lumens: 400LM
- Color temperature: 3000K
- Beam angle: 36°

WARRANTY: 1 years

