

SCX6 SERIES Commercial Lighting

SCX6-4FT-40-60W-MCTP

WESTGATE
THE FUTURE IS HERE...AND IT'S QUITE BRIGHT!



MCTP

Custom:



Selection:



Customer Name: _____

Project Name: _____

Note: _____

Type: _____

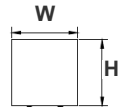
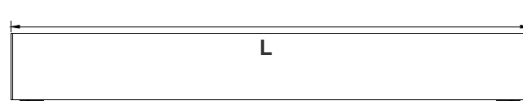

47 1/3"(L) x 6"(W) x 6"(H)

The SCX series offers the best and the most comprehensive selection for linear lighting. The various available lengths and widths allow the creation of the desired shape to elevate the areas aesthetics to a unique and modern look while providing an impressive illumination for the occupants. Ideal for, retail locations, offices, lobbies, conference rooms, reception areas, hallways, educational facilities, hotels, and restaurants. FEATURES: Superior Architectural Look Energy-efficient: Low Wattage Consumption & High Lumen Output Easier Wire Management & Install Variety of Mounting Options Multi Color Temperature (Selectable Switch Inside Fixture) Variety Of Factory Customizations Available

Features

- LED Superior Architectural Lights
- Seamless Linkable Linear Lighting System
- Opal Polycarbonate Lens-Direct (DOWN) Lighting
- Optional Recessed & Wall Mounting Kits Available
- Optional Louver Version Lens Available
- Lens Type: Opal Polycarbonate Lens
- MCTP: Multi Color Temperature and Power (Selectable the switches are in the fixture under the lens)

Technical Specifications

Electrical:

- Voltage: 120-277V AC 50/60Hz
- Wattage: 40W/50W/60W
- Power Factor: >0.95
- LPW: 105/ 110/ 115
- Total Harmonic Distortion: ≤ 20 %

Mechanical:

- Low Profile Modern Design
- Aluminum Housing With Matte White Finish
- Custom Colors Available
- Lens Snaps into Housing
- Make Different Connections Via T/L/X Joints on Both Ends
- Mounting Options: Surface, Suspended, Wall, Recessed
- IP Rating: IP54
- Operating Temperature: -13°F~104°F
- Adjustable Suspension Brackets Provided on Top of The Fixtures

Lighting:

- Dimmable: 0~10V Dimming
- Total Lumens: 6900LM Max.
- Color Temperatures: 3000K/3500K/4000K/5000K
- MCTP: Multi Color Temperature and Power (Selectable the switches are in the fixture under the lens)
- Color Rendering Index: CRI ≥ 80
- Up Light Option Available
- 50,000 Hours Rated Life
- 5-Year Warranty
- Beam Angle: 104.8°(H) x 100.5°(V)

Applications:

- Ideal for offices, hotels, corridors, saloons, libraries, meeting rooms, conference halls, and the best solution for modern lighting solutions
- It can be used in any indoor applications

Other Models:

• 30W | 3450LM | SCX6-2FT-20-30W-MCTP • 45W | 5175LM | SCX6-3FT-30-45W-MCTP • 90W | 10350LM | SCX6-6FT-60-90W-MCTP • 120W | 13800LM | SCX6-8FT-80-120W-MCTP



Phone: (877) 805-2252 | Fax: (877) 805-2252
www.westgatemfg.com



WG-Z8-Y7-2Z

Photometrics: SCX6-4FT-40-60W-MCTP

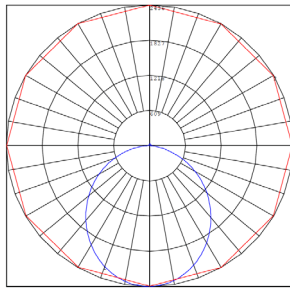
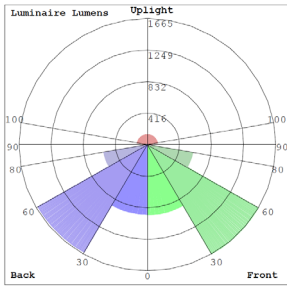

BUD Rating: B2-U3-G1

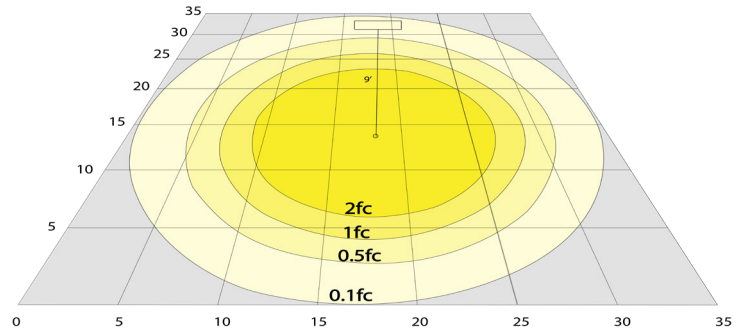

Area 55'x 55' Mounting Height: 9'

Other Views:



Side View



Front View

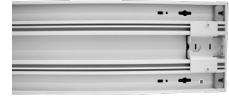

Back View

Performance Table: SCX6-4FT-40-60W-MCTP

MODEL NO.	Wattage	Voltage	Lumens	Color Temp.	BUG Rating	LPW
SCX6-4FT-40-60W-MCTP	40W	120~277V	4200	3000K	B2-U3-G1	105
	50W		5500	3500K		110
	60W		6900	5000K		115

Sample Ordering

Model Size Wattage Wattage Color Temp.

SCX6 - 4FT - 40 - 60W - MCTP

Accessories:



Blank = No Option For Accessories

SCL-CSY1-6FT = ADJ. 6FT 1/16in SINGLE SUSPENSION CANOPY SET WITH Y DOUBLE KEYHOLE END CONNECTORS, NON-POWER SIDE

SCL-CSY1P-6FT = ADJ. 6FT 1/16in SINGLE SUSPENSION CANOPY SET WITH Y DOUBLE KEYHOLE END CONNECTORS, POWER SIDE WITH SJTW18/5 WHITE CORD

SCL-CSY1P-6FT-NC = ADJ. 6FT 1/16in SINGLE SUSPENSION CANOPY SET WITH Y DOUBLE KEYHOLE END CONNECTORS

SCL-GSY10 = ADJUSTABLE 10 FT. 1/16" SUSPENSION KIT WITH Y-CONNECTOR & LOOP GRIP & HOOKS(2)

SCL-GSY20 = ADJUSTABLE 20 FT. 1/16" SUSPENSION KIT WITH Y-CONNECTOR & LOOP GRIP & HOOKS(2)

SCL-GSY110 = ADJ. 10FT 1/16IN SIN GLE SUSPENSION CABLE WITH Y HOOK ENDS, LOOP GRIPPER ON TOP (ORDER 3 FOR 8FT.)(1)

SCL-GSY120 = ADJ. 20FT 1/16IN SINGLE SUSPENSION CABLE WITH Y HOOK ENDS, LOOP GRIPPER ON TOP (ORDER 3 FOR 8FT.)(1)

SCL-6FT-SJTW18/5 = 6ft White Cord, SJTW 18 AWG 5-Conductor (Black, White, Green + Purple & Gray for 0-10V Dimming)

SCL-6FT-SJTW18/5-100FT = 100ft Roll of White Cord, SJTW 18 AWG 5-Conductor (Black, White, Green + Purple & Gray for 0-10V Dimming)

SCL-6FT-SJTW18/5-100FT-BK = 100ft Roll of Black Cord, SJTW 18 AWG 5-Conductor (Black, White, Green + Purple & Gray for 0-10V Dimming)

SCL-6FT-SJTW18/6-100FT = 100ft Roll of Black Cord, SJTW 18 AWG 6-Conductor (Black, White, Green + Purple & Gray for 0-10V Dimming + Red for Backup Invertor)

SCL-AH = Heavy-Duty Auxiliary Hook for Up To 1/16" Aircraft Cable

SCL-ASC-500FT = 1/16" 500 ft. Steel Aircraft Cable Suspension

* More Mounting Options Refer to page 4

Factory-Installed Options:



Blank = No Option For Accessories

OPT-HBC-125BS-WH = 10FT, 15A, 125V, 18/3 STR, WHT

* More Factory-Installed Options Refer to page 6

SUSPENDED MOUNTING ACCESSORIES (NOT INCLUDED)



FACTORY-INSTALLED OPTIONS:



OPT-HBC-125BS-WH

Example:

- SCX6-4FT-40-60W-MCTP (For SCX6 60W MCTP fixture 120-277V)
- SCX6-4FT-40-60W-MCTP OPT-HBC-125BS-WH (For SCX6 60W MCTP fixture 120-277V) (10FT, 15A, 125V, 18/3 STR, WHT)



MOUNTING AND MODULES OPTIONS:



Recessed Mounted
(Flanged)



Surface Mounted



Wall Mounted



Suspended

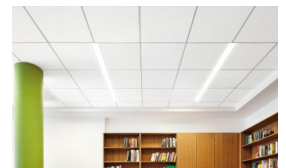

T-Bar Installation

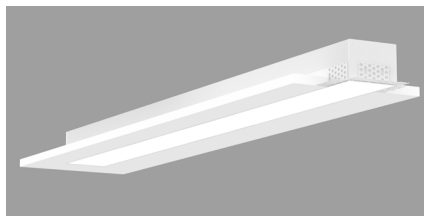

Flangless Recessed Mounted
(Mud-In)

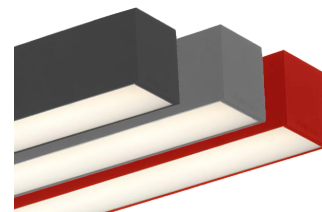

Color of Your Choice

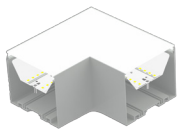

L Module
(page 7)

SCX6-L-MCTP

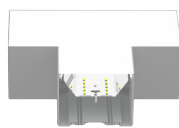

T Module
(page 7)

SCX6-T-MCTP

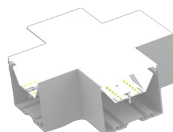

X Module
(page 7)

SCX6-X-MCTP



Inside Corner Module
(page 7)

SCX6-IC-MCTP



Suspension Rod Kit

- SCL-RS-12 12"
- SCL-RS-18 18"
- SCL-RS-24 24"
- SCL-RS-36 36"
- SCL-RS-48 48"

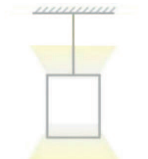

Up Light Option

- 3000K
- 3500K
- 4000K
- 5000K
- Blue
- Green



MOUNTING OPTIONS:

FLANGLSS RECESSED INSTALLATION IN WOOD CEILING

No additional accessories required.
 Make recessed preparations by installing a horizontal plank of wood on top of the wood ceiling at a recessed height of 3 3/8".
 Screw and anchor kit provided with each fixture can be used to fasten the top of the fixture to the wood plank through the holes on top of the fixture.
 You can also install vertical wood boards on top of the ceiling at the edge of the opening and open the fixture and put screws through the side of the fixture housing to fasten it to the wood boards.

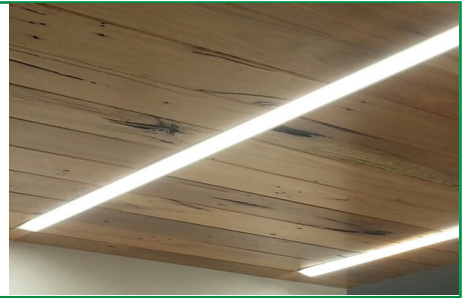

SUSPENSION ROD KITS (SET OF 2)

Model	SIZE
SCL-RS-12	12 IN
SCL-RS-18	18 IN
SCL-RS-24	24 IN
SCL-RS-36	36 IN
SCL-RS-48	48 IN

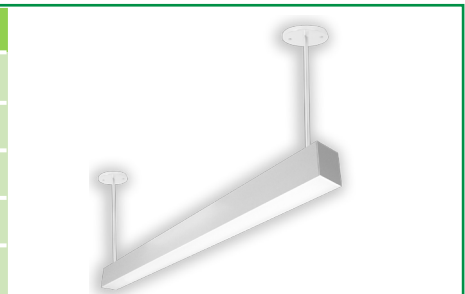

WALL MOUNTING

Model	DESCRIPTION
OPT-SCX-WM-6FT	Install this optional wall mounting brackets on the back of the fixture. Connection cables will enter the fixture through one of these wall-mounting brackets. On your purchase order, please specify the position of where your wire entry from the wall.

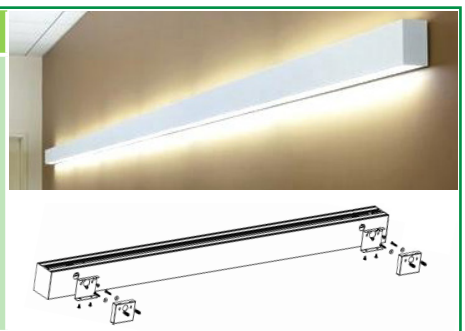

WALL MOUNTING

Model	DESCRIPTION
OPT-SCX-WMA-4FT	Add this option to the fixture, and wall mount brackets will be installed on the back of the fixture. A connection cable will enter the fixture through one of these wall-mounting brackets. On your purchase order, specify the position of your wire entry from the wall, and the brackets will be installed on the back accordingly.

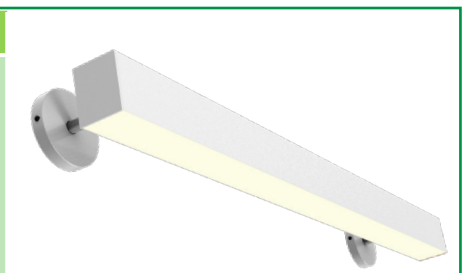

RECESSED MOUNT WITH FLANGE

Model	DESCRIPTION
OPT-SCX-FMR-6FT	Order this option and the fixture will be equipped with a 1/2" wide flange on four sides. Advanced design toggle-style brackets will also be provided, to adjust and hold the fixture against drywall or other hard ceilings from the top. When linking to another fixture or corner module, call us or send a copy of your plan along with your PO, and flanges will be removed on those ends that need to make a seamless connection.

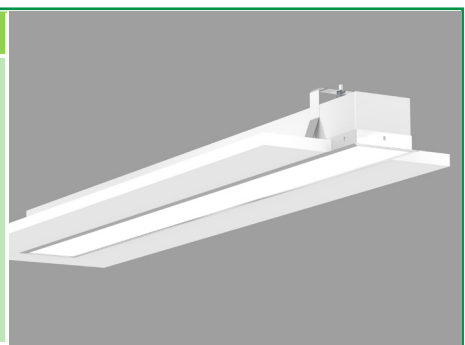

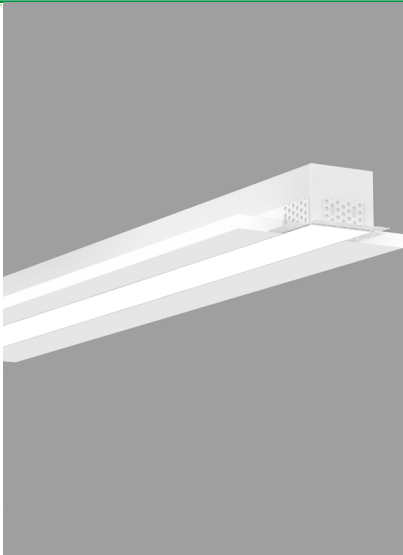

FLANGELESS RECESS MOUNT IN DRYWALL (MUD-IN)

Model	DESCRIPTION
OPT-SCX-MIF-4FT	Order this option and the fixture will be equipped with mud-in brackets on all four sides, mounted at 1/16" from the lens surface (specify if other spacing is needed). Advanced design toggle-style brackets will also be provided, to adjust and hold the fixture against the drywall ceiling from the top. When linking to another fixture or corner fixture module call us or send a copy of your plan along with your PO and flanges will be removed on those end that needs to make a seamless connection.
OPT-SCX-MIF-L	This is a L Module option.
OPT-SCX-MIF-T	This is a T Module option.
OPT-SCX-MIF-X	This is a X Module option.
OPT-SCX-MIF-IC	This is a Inside Corner Module option.



T-BAR INSTALLATION

Model	DESCRIPTION
OPT-SCX-TBAR-4FT	Add this option and 1/2" wide flanges will be installed on the two long sides of the fixture. The two ends of the fixture will fall onto the T-bar grids and will be supported this way. The T-bar tiles on the two sides of the fixture must be cut to allow for the width of the fixture. The tile will fall onto and be supported by the flanges on both sides of the fixture. If you plan to support the fixture by the grids on three sides and tile on one side, call us or specify on your PO, and flange will be installed only on one side of the fixture. To provide safety and support from the beams above the T-bar ceiling order 10ft or 20ft aircraft suspension kits below.
SCL-GSY110	ADJ. 10FT 1/16IN SINGLE SUSPENSION CABLE WITH Y HOOK ENDS, LOOP GRIPPER ON TOP (ORDER 3 FOR 8FT.)(1)
SCL-GSY120	ADJ. 20FT 1/16IN SINGLE SUSPENSION CABLE WITH Y HOOK ENDS, LOOP GRIPPER ON TOP (ORDER 3 FOR 8FT.)(1)
OPT-FWH-63	This is a 6FT 3-Wire Whip option.
OPT-FWH-65	This is a 6FT 5-Wire Whip option.
OPT-FWH-66	This is a 6FT 6-Wire Whip option.

SURFACE MOUNTING

<p>No additional accessories required.</p> <p>Screw and anchor kit provided with each fixture can be used to fasten the fixture directly to the hard surface through the holes on top of the fixture.</p>	
---	---

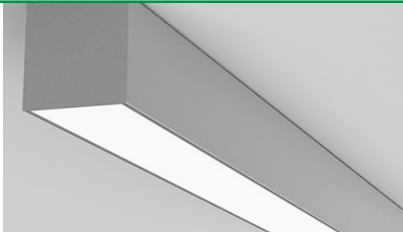

FACTORY-INSTALLED OPTIONS:

COLOR OF YOUR CHOICE

Model	DESCRIPTION
OPT-SCX-CLR-4FT	Add this option and specify your desired color on your purchase order or provide a swatch to match. For painted flanged fixture or optional rod, mounting set please also add the relevant option below for each fixture.
OPT-SCX-CLR-FRM	This is a painted flanges option.
OPT-SCX-CLR-RODSET	This is a painted rod set option.

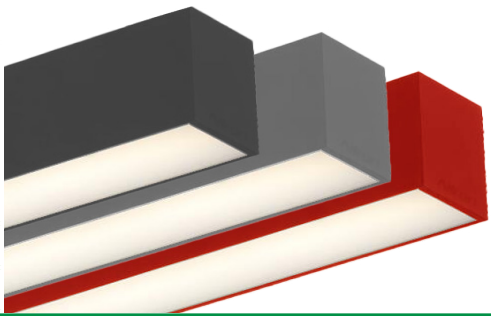

INDIRECT (UP) LIGHTING

Model	WATTS	LUMENS	COLOR TEMP	SIZE
OPT-SCX-ULM-4FT-16W-MCT4	16W	1600LM 1648LM 1680LM 1728LM	3000K 3500K 4000K 5000K	4FT
OPT-SCX-ULM-BU	Indirect (up) light with blue color			
OPT-SCX-ULM-GR	Indirect (up) light with green color			



EMERGENCY BATTERY BACKUP

Model	DESCRIPTION
OPT-EM-SCX6	This is an option for a 90-minute backup battery installation. If you need to order this series for the fixture, please have your purchase order ready and call us or specify on the order which fixture to install this option and the test button.

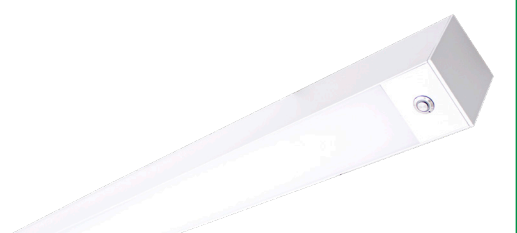

BI-LEVEL MOTION SENSOR

Model	DESCRIPTION
OPT-SEN-SCX6	This option installs an advanced motion sensor that will turn the lights on when the area is occupied. When the area is cleared, after a preset hold time of 5 sec or more the lights are dimmed to a standby level of 30% or more. If still no motion is detected, after the standby period, the light is turned off. All setting is programmable with a remote control.
OPT-WEC-3RC	This is an optional remote control for sensor.



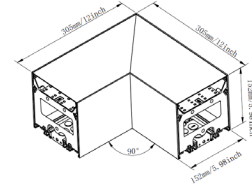
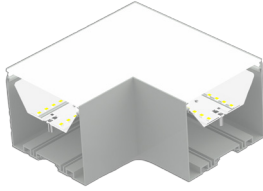

CORNER FIXTURE MODULES:

Built-in LED Modules

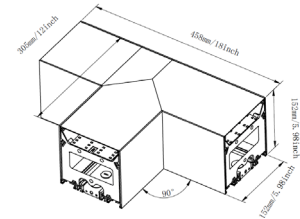
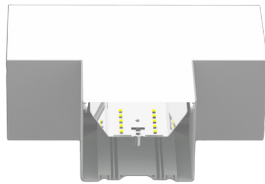

Model	JOINT TYPE	LUMENS	COLOR TEMP	DIMENSION
SCX6-L-MCTP	L	1050-2100LM	3000K 3500K 4000K 5000K	12" X 5.98" X 5.98"



Model	JOINT TYPE	LUMENS	COLOR TEMP	DIMENSION
SCX6-T-MCTP	T	2100-3450LM	3000K 3500K 4000K 5000K	12" X 18" X 5.98"

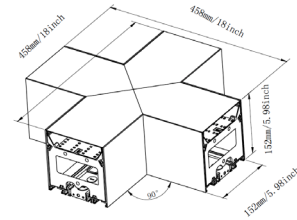
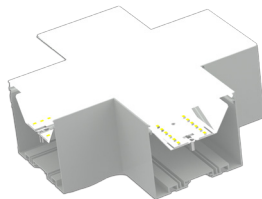

Model	JOINT TYPE	LUMENS	COLOR TEMP	DIMENSION
SCX6-X-MCTP	X	3150-4600LM	3000K 3500K 4000K 5000K	18" X 5.98"

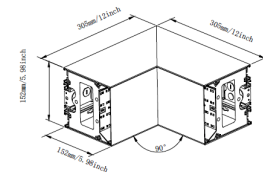
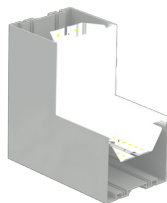

Model	JOINT TYPE	LUMENS	COLOR TEMP	DIMENSION
SCX6-IC-MCTP	INSIDE CORNER	1050-2100LLM	3000K 3500K 4000K 5000K	12" X 12" X 5.98" X 5.98"



COLOR CHART:

* Choose from one of our Premium Colors with no set-up fee.



DARK RED 90
GLOSS
P009-RD02



RED 90 GLOSS
T009-RD03



RED TEXTURE
T241-RD129



RED 90 GLOSS
T009-RD01



INTERNATIONAL
ORANGE 90
GLOSS
T009-OG26



SAFETY ORANGE
90 GLOSS
T009-OG01



YELLOW 90
GLOSS
T009-YL71



FS 13538 YELLOW
90 GLOSS
T009-YL14



YELLOW 90
GLOSS
T009-YL01

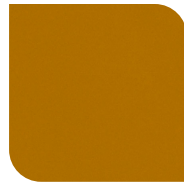

TRACTOR
YELLOW 90
GLOSS
C209-YL130



RAL 8028 TERRA
BROWN 90 GLOSS
C209-BR358



BRONZE 40
GLOSS
P004-BR23



BROWN TEXTURE
T032-BR62

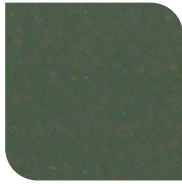

FS 34094 OD
GREEN FLAT
P000-GN264



TRAFFIC GREEN
70 GLOSS
T007-GN16



FS14066 D.O.T
GREEN 70 GLOSS
T007-GN13



GREEN 60 GLOSS
C006-GN03



TRACTOR GREEN
90 GLOSS
C209-GN411



GREY HAMMER
C013-GR08



BEIGE HAMMER
T013-BG38



WHITE HAMMER
T012-WH260



WHITE HAMMER
T013-WH09



RAL 7035 LIGHT
GREY HAMMER
T013-GR185



RED HAMMER
T013-RD15



GREEN HAMMER
T013-GN220

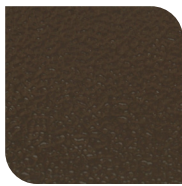

BRONZE HAMMER
T012-BR161



BLACK HAMMER
T013-BK62



BLACK HAMMER
LOW GLOSS
E311-BK04



BLUE TEXTURE
C241-BL544



FS 25109 BLUE
TEXTURE
T032-BL04

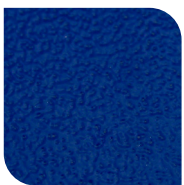

BLUE HAMMER
T013-BL468



BLUE 90 GLOSS
T009-BL01



BLUE 90 GLOSS
T009-BL05



DARK BLUE 80
GLOSS
T008-BL20



BLUE TEXTURE
C241-BL210



BLUE 80 GLOSS
H308-BL03

