

SCX SERIES

Commercial Lighting

WESTGATE
THE FUTURE IS HERE...AND IT'S QUITE BRIGHT!

SCX-3FT-30W-30K-D
SCX-3FT-30W-35K-D
SCX-3FT-30W-40K-D
SCX-3FT-30W-50K-D

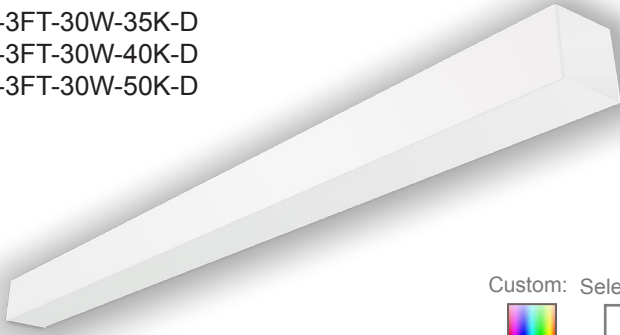

Custom: Selection:



Customer Name: _____

Project Name: _____

Note: _____

Type: _____

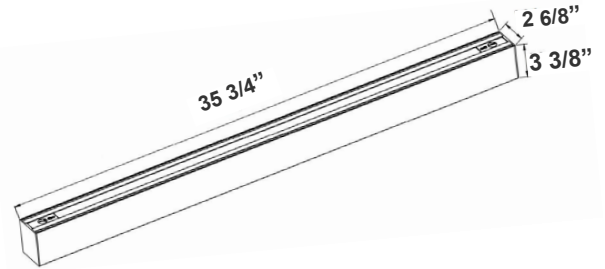

35 3/4" (L) x 2 6/8" (W) x 3 3/8" (H)

Linear Lighting can be customized to your desired length, look & color temperature can either be suspended, surface, mounted or recessed to suit your needs. Ideal for Storage rooms, Offices Conference rooms, Retail Reception areas, Hallways Education facilities, hotels, and restaurants.

Features

- LED Superior Architectural Lights
- Seamless Linkable Linear Lighting System
- Opal Polycarbonate Lens-Direct (DOWN) Lighting
- Optional Recessed & Wall Mounting Kits Available
- 50,000 Hours Rated Life
- 5-Year Warranty
- Lens Type: Opal Polycarbonate Lens
- Optional Louver Version Lens Available

Technical Specifications

Electrical:

- Voltage: 120-277VAC 50/60Hz
- Wattage: 30W
- Power Factor: >0.95

Mechanical:

- Low Profile Modern Design
- Aluminum Housing With Matte White Finish
- Custom Colors Available
- Lens Snaps into Housing
- Make Different Connections Via T/L/X Joints on Both Ends
- Mounting Options: Surface, Suspended, Wall, Recessed
- IP Rating: IP54
- Operating Temperature: -13°F~104°F

Lighting:

- Dimmable: 0~10V Dimming
- Total Lumens: 3360LM/3450LM/3540LM/3630LMC
olor Temperature: 3000K/3500K/4000K /5000K
- Color Rendering Index: CRI ≥ 80
- Up Light Option Available
- Beam Angle: 104.8°(H) x 100.5°(V)

Applications:

- Ideal for offices, hotels, corridors, saloons, libraries, meeting rooms, conference halls, and the best solution for modern lighting solutions
- It can be used in any indoor applications

Other Models:

• 20W | 2240LM | SCX-2FT-20W-30K-D • 40W | 4480LM | SCX-4FT-40W-30K-D • 60W | 6720LM | SCX-6FT-60W-30K-D • 80W | 8960LM | SCX-8FT-80W-30K-D
• 20W | 2300LM | SCX-2FT-20W-35K-D • 40W | 4600LM | SCX-4FT-40W-35K-D • 60W | 6900LM | SCX-6FT-60W-35K-D • 80W | 9200LM | SCX-8FT-80W-35K-D
• 20W | 2360LM | SCX-2FT-20W-40K-D • 40W | 4720LM | SCX-4FT-40W-40K-D • 60W | 7080LM | SCX-6FT-60W-40K-D • 80W | 9440LM | SCX-8FT-80W-40K-D
• 20W | 2420LM | SCX-2FT-20W-50K-D • 40W | 4840LM | SCX-4FT-40W-50K-D • 60W | 7260LM | SCX-6FT-60W-50K-D • 80W | 9680LM | SCX-8FT-80W-50K-D



Phone: (877) 805-2252 | Fax: (877) 805-2252
www.westgatemfg.com



WG-Z5-ZB-22

Photometrics: SCX-3FT

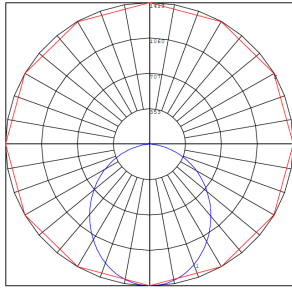
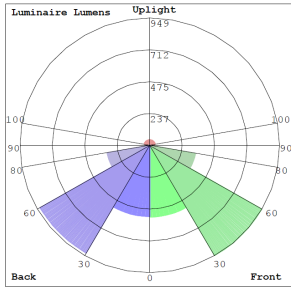

BUD Rating: B2-U2-G1

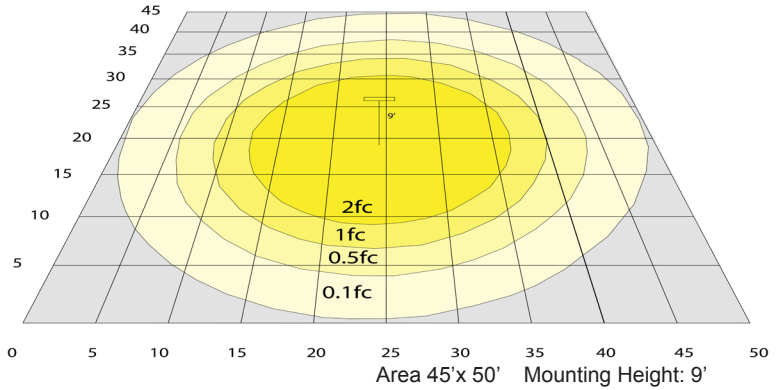

Area 45'x 50' Mounting Height: 9'

Other Views:



Front View



Side View



Back View

Performance Table: SCX-3FT

MODEL NO.	Wattage	Voltage	Lumens	Color Temp.	BUG Rating	LPW
SCX-3FT-30W-30K-D	30W	120~277V	3360LM	3000K	B2-U2-G1	112
SCX-3FT-30W-35K-D	30W	120~277V	3450LM	3500K	B2-U2-G1	116
SCX-3FT-30W-40K-D	30W	120~277V	3540LM	4000K	B2-U2-G1	118
SCX-3FT-30W-50K-D	30W	120~277V	3630LM	5000K	B2-U2-G1	121

Sample Ordering

Model	Size	Wattage	Color Temp.	Feature
SCX	3FT	30W		D

30K = 3000K
35K = 3500K
40K = 4000K
50K = 5000K

Accessories:

Blank = No Option For Accessories

- SCL-CS1-6FT = ADJ. 6FT 1/16in SINGLE SUSPENSION CANOPY SET WITH KEYHOLE END CONNECTOR, NON-POWER SIDE
- SCL-CS1P-6FT = ADJ. 6FT 1/16in SINGLE SUSPENSION CANOPY SET WITH KEYHOLE END CONNECTOR, POWER SIDE WITH SJTW18/5 WHITE CORD
- SCL-CS1P-6FT-NC = ADJ. 6FT 1/16in SINGLE SUSPENSION CANOPY SET WITH KEYHOLE END CONNECTOR
- SCL-GS10 = ADJ. 10FT 1/16in DOUBLE SUSPENSION CABLE WITH SINGLE KEYHOLE CONN., LOOP GRIPPER ON TOP
- SCL-GS20 = ADJ. 20FT 1/16in DOUBLE SUSPENSION CABLE WITH SINGLE KEYHOLE CONN., LOOP GRIPPER ON TOP
- SCL-6FT-SJTW18/5 = 6ft White Cord, SJTW 18 AWG 5-Conductor (Black, White, Green + Purple & Gray for 0-10V Dimming)
- SCL-6FT-SJTW18/5-100FT = 100ft Roll of White Cord, SJTW 18 AWG 5-Conductor (Black, White, Green + Purple & Gray for 0-10V Dimming)
- SCL-6FT-SJTW18/5-100FT-BK = 100ft Roll of Black Cord, SJTW 18 AWG 5-Conductor (Black, White, Green + Purple & Gray for 0-10V Dimming)
- SCL-6FT-SJTW18/6-100FT = 100ft Roll of Black Cord, SJTW 18 AWG 6-Conductor (Black, White, Green + Purple & Gray for 0-10V Dimming + Red for Backup Inverter)
- SCL-AH = Heavy-Duty Auxiliary Hook for Up To 1/16" Aircraft Cable
- SCL-ASC-500FT = 1/16" 500 ft. Steel Aircraft Cable Suspension

* More Mounting Options Refer to page 3

Factory-Installed Options:

Blank = No Option For Accessories
OPT-HBC-125BS-WH = 10FT, 15A, 125V, 18/3 STR, WHT

* More Factory-Installed Options Refer to page 3

SUSPENDED MOUNTING ACCESSORIES (NOT INCLUDED)



SCL-CS1-6FT SCL-CS1P-6FT SCL-CS1P-6FT-NC SCL-GS10 SCL-GS20

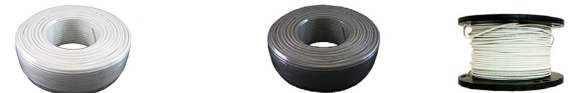

SCL-6FT-SJTW18/5-100FT SCL-6FT-SJTW18/5-100FT-BK SCL-ASC-500FT
SCL-6FT-SJTW18/6-100FT



SCL-AH SCL-ASC-500FT SCL-6FT-SJTW18/5

FACTORY-INSTALLED OPTIONS:



Example:

- SCX-3FT-30W-40K-D (For SCX 30W 4000K fixture 120-277V)
- SCX-3FT-30W-40K-D OPT-HBC-125BS-WH (For SCX 30W 4000K fixture 120-277V (10FT, 15A, 125V, 18/3 STR, WHT))



MOUNTING AND MODULES OPTIONS:

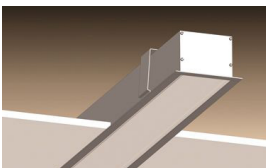

Recessed Mounted
(Flanged)



Surface Mounted



Wall Mounted



Suspended



T-Bar Installation

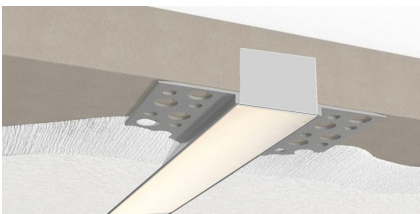

Flangless Recessed Mounted
(Mud-In)



Louver Kit Option

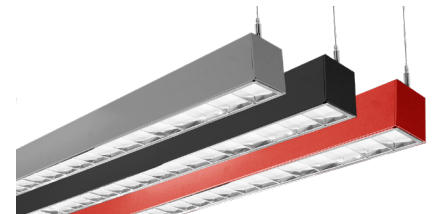

Color of Your Choice

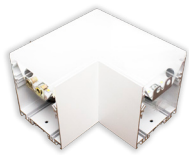

L Module
(page 7)

- SCX-L-30K
- SCX-L-35K
- SCX-L-40K
- SCX-L-50K



T Module
(page 7)

- SCX-T-30K
- SCX-T-35K
- SCX-T-40K
- SCX-T-50K

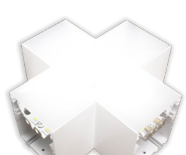

X Module
(page 8)

- SCX-X-30K
- SCX-X-35K
- SCX-X-40K
- SCX-X-50K



Inside Corner Module
(page 8)

- SCX-IC-30K
- SCX-IC-35K
- SCX-IC-40K
- SCX-IC-50K



120° Corner Module
(page 9)

- SCX-C120-30K
- SCX-C120-35K
- SCX-C120-40K
- SCX-C120-50K



Suspension Rod Kit

- SCL-RS-12 12"
- SCL-RS-18 18"
- SCL-RS-24 24"
- SCL-RS-36 36"
- SCL-RS-48 48"

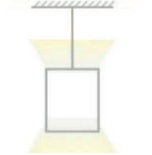

Up Light Option

- 3000K
- 3500K
- 4000K
- 5000K
- Blue
- Green



MOUNTING OPTIONS:

FLANGLSS RECESSED INSTALLATION IN WOOD CEILING

No additional accessories required.
 Make recessed preparations by installing a horizontal plank of wood on top of the wood ceiling at a recessed height of 3 3/8".
 Screw and anchor kit provided with each fixture can be used to fasten the top of the fixture to the wood plank through the holes on top of the fixture.
 You can also install vertical wood boards on top of the ceiling at the edge of the opening and open the fixture and put screws through the side of the fixture housing to fasten it to the wood boards.

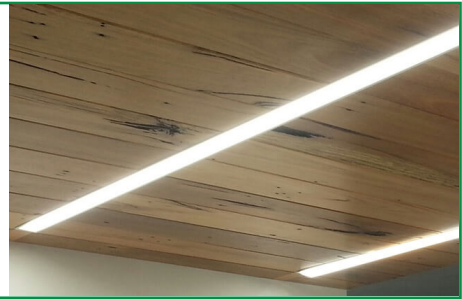

SUSPENSION ROD KITS (SET OF 2)

Model	SIZE
SCL-RS-12	12 IN
SCL-RS-18	18 IN
SCL-RS-24	24 IN
SCL-RS-36	36 IN
SCL-RS-48	48 IN

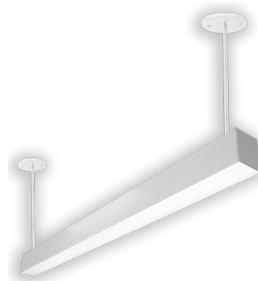

WALL MOUNTING

Model	DESCRIPTION
OPT-SCX-WM-3FT	Install this optional wall mounting brackets on the back of the fixture. Connection cables will enter the fixture through one of these wall-mounting brackets. On your purchase order, please specify the position of where your wire entry from the wall.

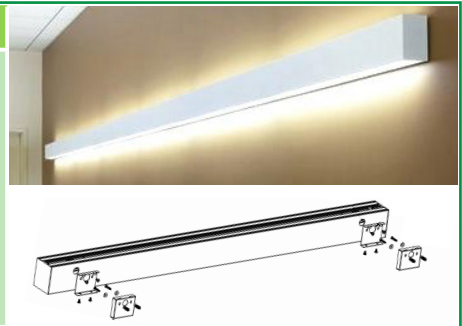

RECESSED MOUNT WITH FLANGE

Model	DESCRIPTION
OPT-SCX-FMR-3FT	Order this option and the fixture will be equipped with a 1/2" wide flange on four sides. Advanced design toggle-style brackets will also be provided, to adjust and hold the fixture against drywall or other hard ceilings from the top. When linking to another fixture or corner module, call us or send a copy of your plan along with your PO, and flanges will be removed on those ends that need to make a seamless connection.

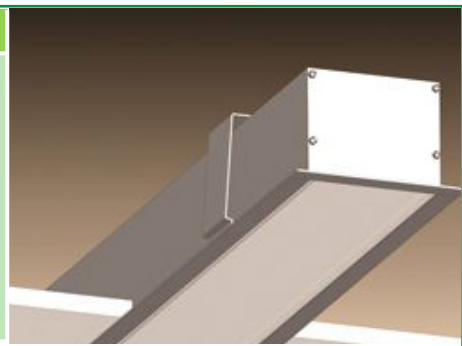

LINKING

Model	DESCRIPTION
OPT-SCX-LINKWIRING	Fixtures are equipped with pre-installed linking brackets and accessories and only need to be wired together. to receive a fixture prewired for linking, order the option below for each link to another fixture or a corner module.



FLANGELESS RECESS MOUNT IN DRYWALL (MUD-IN)

Model	DESCRIPTION
OPT-SCX-MIF-3FT	Order this option and the fixture will be equipped with mud-in brackets on all four sides, mounted at 1/16" from the lens surface (specify if other spacing is needed). Advanced design toggle-style brackets will also be provided, to adjust and hold the fixture against the drywall ceiling from the top. When linking to another fixture or corner fixture module call us or send a copy of your plan along with your PO and flanges will be removed on those end that needs to make a seamless connection.
OPT-SCX-MIF-L	This is a L Module option.
OPT-SCX-MIF-T	This is a T Module option.
OPT-SCX-MIF-X	This is a X Module option.
OPT-SCX-MIF-IC	This is a Inside Corner Module option.

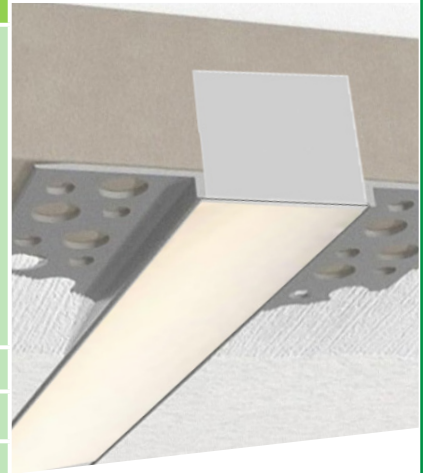

SURFACE MOUNTING

<p>No additional accessories required.</p> <p>Screw and anchor kit provided with each fixture can be used to fasten the fixture directly to the hard surface through the holes on top of the fixture.</p>	
---	--



FACTORY-INSTALLED OPTIONS:

LOUVER VERSION

Model	DESCRIPTION	LUMENS @ 4000K	SIZE
OPT-SCX-LUV-3FT	This Louver option includes lens inside.	3240LM	3FT



COLOR OF YOUR CHOICE

Model	DESCRIPTION
OPT-SCX-CLR-3FT	Add this option and specify your desired color on your purchase order or provide a swatch to match. For painted flanged fixture or optional rod, mounting set please also add the relevant option below for each fixture.
OPT-SCX-CLR-FRM	This is a painted flanges option.
OPT-SCX-CLR-RODSET	This is a painted rod set option.

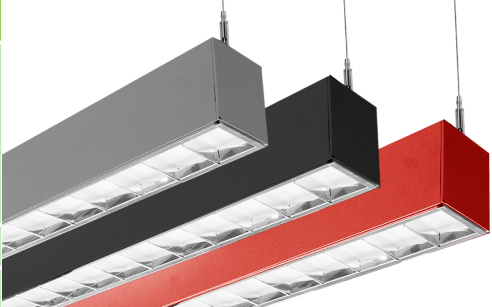

INDIRECT (UP) LIGHTING

Model	WATTS	LUMENS	COLOR TEMP	SIZE
OPT-SCX-ULM-3FT-12W-30K	12W	1200LM	3000K	3FT
OPT-SCX-ULM-3FT-12W-35K	12W	1236LM	4000K	3FT
OPT-SCX-ULM-3FT-12W-40K	12W	1260LM	5000K	3FT
OPT-SCX-ULM-3FT-12W-50K	12W	1296LM	6000K	3FT
OPT-SCX-ULM-BU	Indirect (up) light with blue color			
OPT-SCX-ULM-GR	Indirect (up) light with green color			



EMERGENCY BATTERY BACKUP

Model	DESCRIPTION
OPT-EM-CM1INT	This is an option for a 90-minute backup battery installation. If you need to order this series for the fixture, please have your purchase order ready and call us or specify on the order which fixture to install this option and the test button.

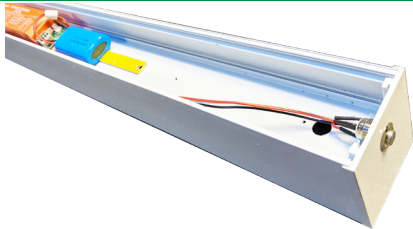

BI-LEVEL MOTION SENSOR

Model	DESCRIPTION
OPT-SCX-SEN2US	This option installs an advanced motion sensor that will turn the lights on when the area is occupied. When the area is cleared, after a preset hold time of 5 sec or more the lights are dimmed to a standby level of 30% or more. If still no motion is detected, after the standby period, the light is turned off. All setting is programmable with a remote control.
OPT-WEC-3RC	This is an optional remote control for sensor.
OPT-SEN-SCX-2MRLV-5	This is a programmable microwave Bi-Level sensor.
OPT-SEN-2US-DAYLIGHT	It is an ultrasonic Bi-Level Dimming Daylight sensor option for internal installation inside the fixture. (Remote not needed)



CORNER FIXTURE MODULES:

Built-in LED Modules

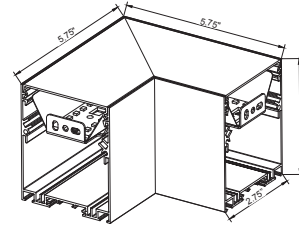
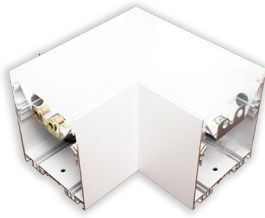

Model	JOINT TYPE	LUMENS	COLOR TEMP	DIMENSION
SCX-L-30K	L	508LM	3000K	5.75" X 5.75" X 3.35" X 2.75"
SCX-L-35K	L	575LM	3500K	5.75" X 5.75" X 3.35" X 2.75"
SCX-L-40K	L	616LM	4000K	5.75" X 5.75" X 3.35" X 2.75"
SCX-L-50K	L	660LM	5000K	5.75" X 5.75" X 3.35" X 2.75"

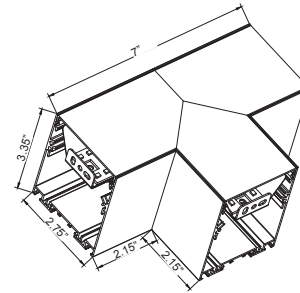

Model	JOINT TYPE	LUMENS	COLOR TEMP	DIMENSION
SCX-T-30K	T	629LM	3000K	7" X 3.35" X 2.75" X 2.15" X 2.15"
SCX-T-35K	T	726LM	3500K	7" X 3.35" X 2.75" X 2.15" X 2.15"
SCX-T-40K	T	787LM	4000K	7" X 3.35" X 2.75" X 2.15" X 2.15"
SCX-T-50K	T	854LM	5000K	7" X 3.35" X 2.75" X 2.15" X 2.15"

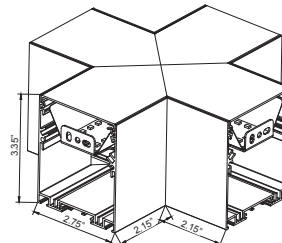
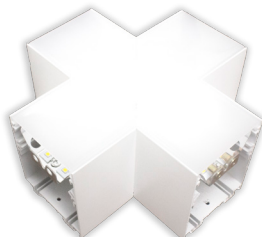

Model	JOINT TYPE	LUMENS	COLOR TEMP	DIMENSION
SCX-X-30K	X	733LM	3000K	3.35" X 2.75" X 2.15" X 2.15"
SCX-X-35K	X	863LM	3500K	3.35" X 2.75" X 2.15" X 2.15"
SCX-X-40K	X	944LM	4000K	3.35" X 2.75" X 2.15" X 2.15"
SCX-X-50K	X	1037LM	5000K	3.35" X 2.75" X 2.15" X 2.15"



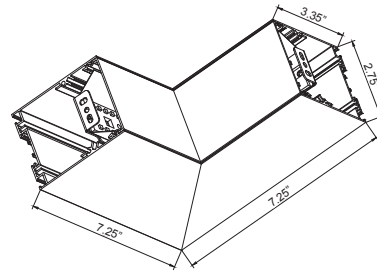

Model	JOINT TYPE	LUMENS	COLOR TEMP	DIMENSION
SCX-IC-30K	INSIDE CORNER	629LM	3000K	7.25" X 7.25" X 3.35" X 2.75"
SCX-IC-35K	INSIDE CORNER	726LM	3500K	7.25" X 7.25" X 3.35" X 2.75"
SCX-IC-40K	INSIDE CORNER	787LM	4000K	7.25" X 7.25" X 3.35" X 2.75"
SCX-IC-50K	INSIDE CORNER	854LM	5000K	7.25" X 7.25" X 3.35" X 2.75"

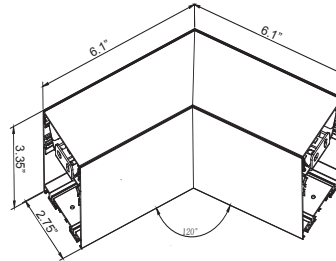

Model	JOINT TYPE	LUMENS	COLOR TEMP	DIMENSION
SCX-C120-30K	120° CORNER	508LM	3000K	6.1" X 6.1" X 3.35" X 2.75"
SCX-C120-35K	120° CORNER	575LM	3500K	6.1" X 6.1" X 3.35" X 2.75"
SCX-C120-40K	120° CORNER	616LM	4000K	6.1" X 6.1" X 3.35" X 2.75"
SCX-C120-50K	120° CORNER	660LM	5000K	6.1" X 6.1" X 3.35" X 2.75"

Example:

1. SCX-3FT-30W-40K-D (For SCX 30W 4000K fixture 120-277V)
2. SCX-3FT-30W-40K-D (For SCX 30W 4000K fixture 120-277V)
 SCL-CS (Adjustable 6ft 1/16" Aircraft Cable Suspension Kit with Canopy for Ceiling or T-Bar)
 OPT-HBC-125BS-WH (10FT, 15A, 125V, 18/3 STR, WHT)

