

LHCX SERIES Industrial Lighting

LHCX-255-320W-MCTP-SR
X-GENERATION COMPACT LINEAR HIGHBAY

MCTP Multi Color Temperature & Multi Power/Wattage (Selectable)

WESTGATE
THE FUTURE IS HERE...AND IT'S QUITE BRIGHT!



Customer Name: _____

Project Name: _____

Note: _____

Type: _____

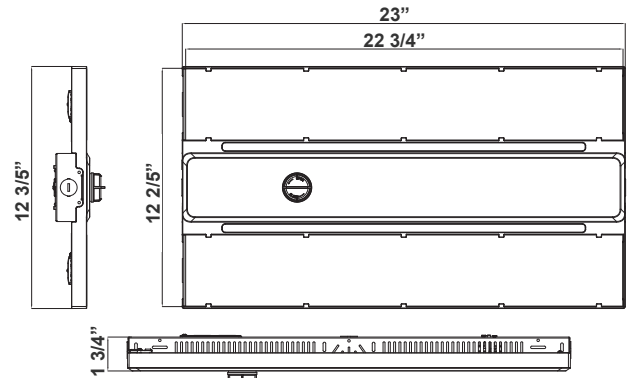

12 3/5" (L) X 22 3/4" (W) X 1 3/4" (H)

Ideal for replacement of conventional lighting systems such as HID and fluorescent. Applications include manufacturing warehousing and other large indoor spaces with mounting heights from 10ft. to 40ft. the fixture can be surface mounted also.

Features

- High Quality LED Chips to provide high efficiency, heat dissipation
- Stability, and lumen maintenance
- Multi CCT and Power: The Switch is in the driver
- Polycarbonate lens, high flame retardant point.

Technical Specifications

Electrical:

- Voltage: 120~277V AC/50~60 Hz
- Wattage: 255W/290W/320W
- Power Factor: >0.95
- Efficacy: 140 LM/W

Mechanical:

- Surge Protector
- Steel Housing
- Steel Thickness: 24 Gauge
- V-Hooks
- Aluminum LED board
- Operating Temperature: -4°F ~ 131°F
- Suitable For Damp Locations
- 5-Year Warranty

Lighting:

- Dimming: 1~10V Dimmable
- Multi CCT and Power: The Switch is On The Driver
- Lens: Polycarbonate Lens
- Total Lumens: 44800LM Max.
- Color Temperatures: 3000K/4000K/5000K
- Color Rendering Index: >80
- Wide Beam angle
- LED SMD type: Edison 2835
- 50,000 Hours Rated Life

Applications:

- Warehouse
- Manufacturing Plants Distribution Centers
- Industrial Commercial
- Grocery Stores Gymsnasiums

Other Models:

- 150W | 21000LM | LHCX-110-150W-MCTP-SR
- 215W | 30100LM | LHCX-165-215W-MCTP-SR



Phone: (877) 805-2252 | Fax: (877) 805-2252
www.westgatemfg.com



Photometrics: LHCX-255-320W-MCTP-SR

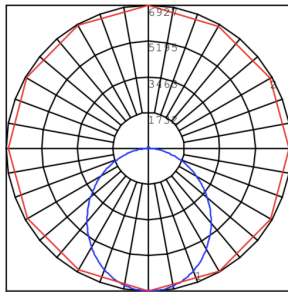
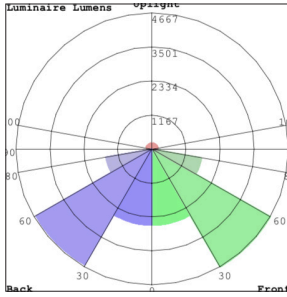

BUG Rating: B5-U3-G4

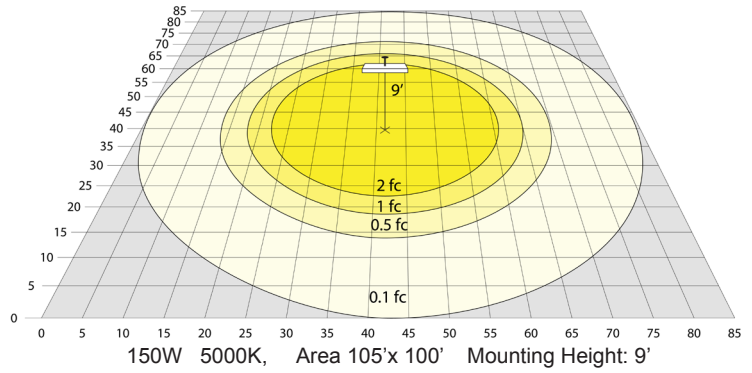

Other Views:

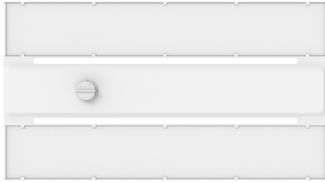

Front View



Side View



Back View

Performance Table: LHCX-255-320W-MCTP-SR

MODEL NO.	Wattage	Voltage	Lumens	Color Temp.	BUG Rating	LPW
LHCX-255-320W-MCTP-SR	255W 290W 320W	120~277V	35700LM 40600LM 44800LM	3000K 4000K 5000K	B4-U3-G2	140

Sample Ordering

Model Wattage Wattage Color Temp. Sensor Ready

LHCX - 255 - 320W - MCTP - SR

Accessory Options:

LHCX-SMK = SURFACE-MOUNTING KIT
 LHCX-WG3 = WIREGUARD FOR 320W MAX MODEL
 WEC-3MR-72-TLB-BK = 600W MAX, ZHAGA 12-24VDC MICROWAVE SENSOR, BLACK, WITH BASE (OPTIONAL REMOTE CONTROL WEC-3RC)
 WEC-3MBT-72-TLB-BK = 600W MAX, ZHAGA 12-24VDC MICROWAVE SENSOR, BLUETOOTH APP READY, BLACK, WITH BASE (OPTIONAL REMOTE CONTROL WEC-3RC)
 WEC-3PR-72-TLB-WH = 600W MAX, ZHAGA 12-24VDC PIR SENSOR, WHITE, WITH BASE (OPTIONAL REMOTE CONTROL WEC-3RC)

Factory-Installed Options:

Blank = No Option
 OPT-SEN-LLHB4 = MICROWAVE Bi-Level SENSOR
 OPT-EM-HB4EXT = EXTERNAL EMERGENCY BATTERY BACKUP
 OPT-FWH-63 = 6FT 3-WIRE WHIP
 OPT-FWH-65 = 6FT 5-WIRE WHIP
 OPT-FWH-66 = 6FT 6-WIRE WHIP
 OPT-HBC-125TL-WH = 8FT, 15A, 125V, WHITE
 OPT-HBC-277TL-WH = 8FT, 15A, 277V, WHITE
 OPT-HBC-125SB-WH = 10FT, 15A, 125V, 18/3STR, WHT

OPTIONAL ACCESSORIES

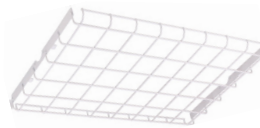

LHCX-WG2



WEC-3PR-72-TLB-WH



WEC-3MR-72-TLB-BK
 WEC-3MBT-72-TLB-BK

FACTORY-INSTALLED OPTION:



OPT-EM-HB4EXT



OPT-SEN-LLHB4



OPTIONAL ACCESSORIES

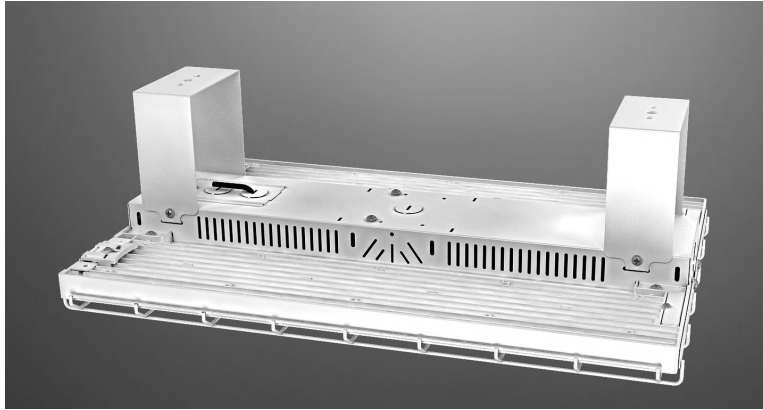

LHCX SMK



LHCX SMK



LHCX WIREGUARD

