

# SCX SERIES

Commercial Lighting

**WESTGATE**  
THE FUTURE IS HERE...AND IT'S QUITE BRIGHT!

SCX-8FT-80W-MCT4-D



Selection:



Custom:



Customer Name: \_\_\_\_\_

Project Name: \_\_\_\_\_

Note: \_\_\_\_\_

Type: \_\_\_\_\_

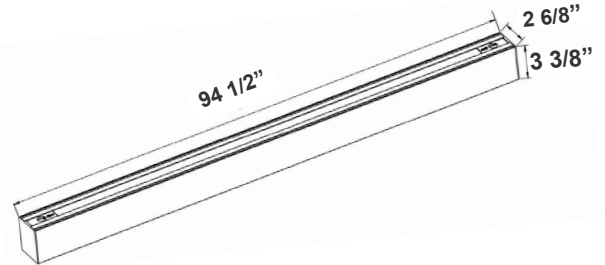

94 1/2"(L) x 2 6/8"(W) x 3 3/8"(H)

Linear Lighting can customize your desired length, look, and color temperature to either be suspended, surface mounted, or recessed to suit your needs. Ideal for Storage rooms, Offices Conference rooms, Retail Reception areas, Hallways Education facilities, hotels, and restaurants.

## Features

- LED Superior Architectural Lights
- Seamless Linkable Linear Lighting System
- Opal Polycarbonate Lens-Direct (DOWN) Lighting
- Optional Recessed & Wall Mounting Kits Available
- Optional Louver Version Lens Available
- Lens Type: Opal Polycarbonate Lens
- MCT: Multi Color Temperature (Selectable Switch Inside Fixture)

## Technical Specifications

### Electrical:

- Voltage: 120-277VAC 50/60Hz
- Wattage: 80W
- Power Factor: >0.95

### Mechanical:

- Low Profile Modern Design
- Aluminum Housing With Matte White Finish
- Custom Colors Available
- Lens Snaps into Housing
- Make Different Connections Via T/L/X Joints on Both Ends
- Mounting Options: Surface, Suspended, Wall, Recessed
- IP Rating: IP54
- Operating Temperature: -13°F~104°F

### Lighting:

- Dimmable: 0~10V Dimming
- Total Lumens: 8750M/ 9224LM/ 9386LM/ 9420LM
- Color Temperatures: 3000K/3500K/4000K/5000K
- Multi-CCT(Selectable Switch Inside Fixture)
- Color Rendering Index: CRI ≥ 80
- Up Light Option Available
- 50,000 Hours Rated Life
- 5-Year Warranty

### Applications:

- Ideal for offices, hotels, corridors, saloons, libraries, meeting rooms, conference halls, and the best solution for modern lighting solutions
- It can be used in any indoor applications

### Other Models:

• 20W | 2390LM | SCX-2FT-20W-MCT4-D • 30W | 3551LM | SCX-3FT-30W-MCT4-D • 40W | 4710LM | SCX-4FT-40W-MCT4-D • 60W | 7102LM | SCX-6FT-60W-MCT4-D



Phone: (877) 805-2252 | Fax: (877) 805-2252  
www.westgatefmg.com | www.westgatecontrols.co



WG-Z5-ZB-22

## Photometrics: SCX-8FT-MCT4

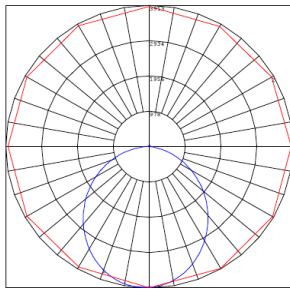
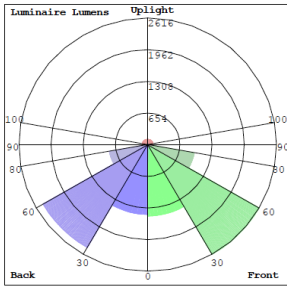

BUD Rating: B3-U3-G2

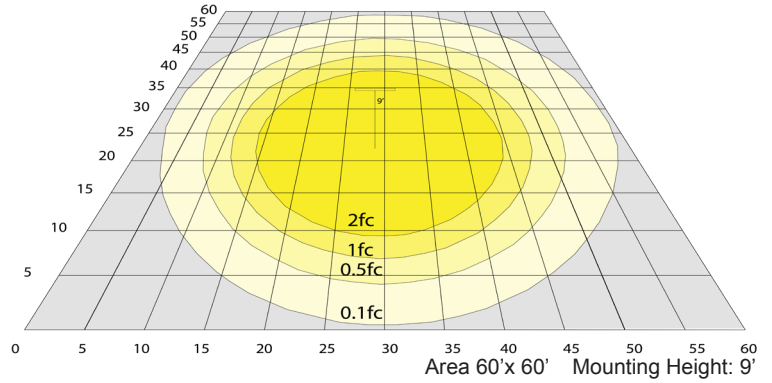

## Other Views:



Front View



Side View



Back View

## Performance Table: SCX-8FT-MCT4

MODEL NO.	Wattage	Voltage	Lumens	Color Temp.	BUG Rating	LPW
SCX-8FT-80W-MCT4-D	80W	120~277V	8750LM	3000K	B3-U3-G2	105
			9224LM	3500K		110
			9386LM	4000K		111
			9420LM	5000K		117

## Sample Ordering

Model	Size	Wattage	Color Temp.	Feature
SCX	8FT	80W	MCT4	D

## Accessories:

Blank = No Option For Accessories

SCL-CS = FOR UP TO 6FT FIXTURES Adjustable 6ft 1/16" Aircraft Cable Suspension Kit with Canopy for Ceiling or T-Bar

SCL-CS3 = FOR 8FT FIXTURES Adjustable 6ft 1/16" Aircraft Cable Suspension Kit with Canopy for Ceiling or T-Bar

SCL-6FT-SJTW18/5 = 6ft White Cord, SJTW 18 AWG 5-Conductor (Black, White, Green + Purple & Gray for 0-10V Dimming)

SCL-6FT-SJTW18/5-100FT = 100ft Roll of White Cord, SJTW 18 AWG 5-Conductor (Black, White, Green + Purple & Gray for 0-10V Dimming)

SCL-6FT-SJTW18/5-100FT-BK = 100ft Roll of Black Cord, SJTW 18 AWG 5-Conductor (Black, White, Green + Purple & Gray for 0-10V Dimming)

SCL-6FT-SJTW18/6-100FT = 100ft Roll of Black Cord, SJTW 18 AWG 6-Conductor (Black, White, Green + Purple & Gray for 0-10V Dimming + Red for Backup Inverter)

SCL-AH = Heavy-Duty Auxiliary Hook for Up To 1/16" Aircraft Cable

SCL-ASC-500FT = 1/16" 500 ft. Steel Aircraft Cable Suspension

\* More Mounting Options Refer to page 4

## Factory-Installed Options:

Blank = No Option For Accessories

OPT-HBC-125BS-WH = 10FT, 15A, 125V, 18/3 STR, WHT

\* More Factory-Installed Options Refer to page 6

## Example:

- SCX-8FT-80W-MCT4-D (For SCX 80W MCT4 fixture 120-277V)
- SCX-8FT-80W-MCT4-D (For SCX 80W MCT4 fixture 120-277V)  
OPT-HBC-125BS-WH (10FT, 15A, 125V, 18/3 STR, WHT)

## SUSPENDED MOUNTING ACCESSORIES (NOT INCLUDED)



SCL-CS



SCL-CS3



SCL-6FT-SJTW18/5-100FT  
SCL-6FT-SJTW18/6-100FT



SCL-6FT-SJTW18/5-100FT-BK



SCL-ASC-500FT



SCL-AH



SCL-ASC-500FT



SCL-6FT-SJTW18/5

## FACTORY-INSTALLED OPTIONS:



OPT-HBC-125BS-WH



# MOUNTING AND MODULES OPTIONS:

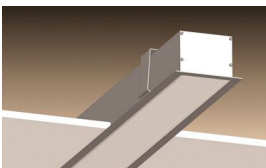

Recessed Mounted  
(Flanged)



Surface Mounted

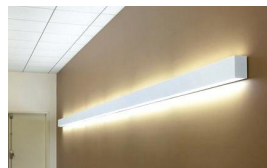

Wall Mounted



Suspended



T-Bar Installation

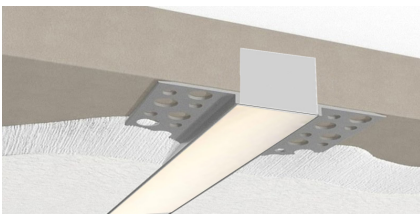

Flangless Recessed Mounted  
(Mud-In)



Louver Kit Option

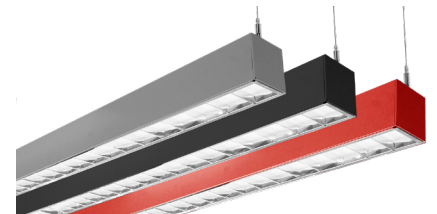

Color of Your Choice

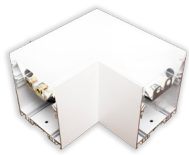

L Module  
(page 7)

- SCX-L-30K
- SCX-L-35K
- SCX-L-40K
- SCX-L-50K



T Module  
(page 7)

- SCX-T-30K
- SCX-T-35K
- SCX-T-40K
- SCX-T-50K

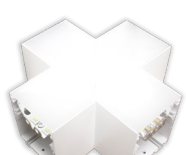

X Module  
(page 8)

- SCX-X-30K
- SCX-X-35K
- SCX-X-40K
- SCX-X-50K



Inside Corner Module  
(page 8)

- SCX-IC-30K
- SCX-IC-35K
- SCX-IC-40K
- SCX-IC-50K

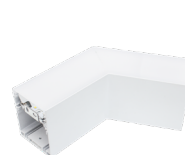

120° Corner Module  
(page 9)

- SCX-C120-30K
- SCX-C120-35K
- SCX-C120-40K
- SCX-C120-50K



Suspension Rod Kit

- SCL-RS-12 12"
- SCL-RS-18 18"
- SCL-RS-24 24"
- SCL-RS-36 36"
- SCL-RS-48 48"

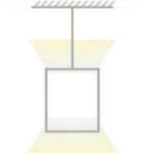

Up Light Option

- 3000K
- 3500K
- 4000K
- 5000K
- Blue
- Green



## MOUNTING OPTIONS:

### FLANGLSS RECESSED INSTALLATION IN WOOD CEILING

No additional accessories required.

Make recessed preparations by installing a horizontal plank of wood on top of the wood ceiling at a recessed height of 3 3/8".

Screw and anchor kit provided with each fixture can be used to fasten the top of the fixture to the wood plank through the holes on top of the fixture.

You can also install vertical wood boards on top of the ceiling at the edge of the opening and open the fixture and put screws through the side of the fixture housing to fasten it to the wood boards.

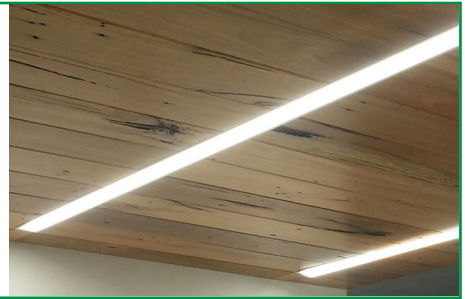

### SUSPENSION ROD KITS (SET OF 2)

Model	SIZE
SCL-RS-12	12 IN
SCL-RS-18	18 IN
SCL-RS-24	24 IN
SCL-RS-36	36 IN
SCL-RS-48	48 IN

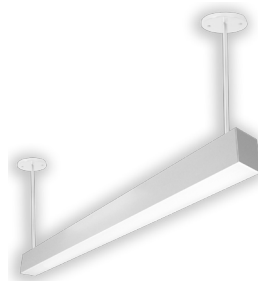

### WALL MOUNTING

Model	DESCRIPTION
OPT-SCX-WM-8FT	Install this optional wall mounting brackets on the back of the fixture. Connection cables will enter the fixture through one of these wall-mounting brackets. On your purchase order, please specify the position of where your wire entry from the wall.

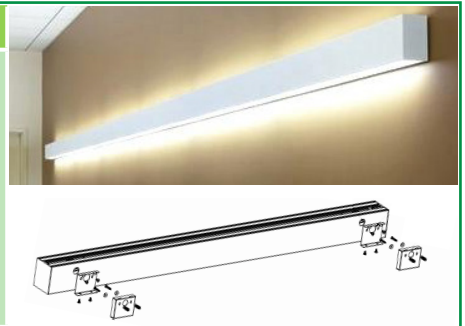

### RECESSED MOUNT WITH FLANGE

Model	DESCRIPTION
OPT-SCX-FMR-8FT	Order this option and the fixture will be equipped with a 1/2" wide flange on four sides. Advanced design toggle-style brackets will also be provided, to adjust and hold the fixture against drywall or other hard ceilings from the top. When linking to another fixture or corner module, call us or send a copy of your plan along with your PO, and flanges will be removed on those ends that need to make a seamless connection.

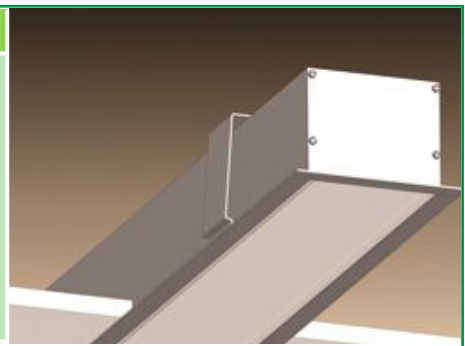

### LINKING

Model	DESCRIPTION
OPT-SCX-LINKWIRING	Fixtures are equipped with pre-installed linking brackets and accessories and only need to be wired together. to receive a fixture prewired for linking, order the option below for each link to another fixture or a corner module.



## FLANGELESS RECESS MOUNT IN DRYWALL (MUD-IN)

Model	DESCRIPTION
OPT-SCX-MIF-8FT	Order this option and the fixture will be equipped with mud-in brackets on all four sides, mounted at 1/16" from the lens surface (specify if other spacing is needed). Advanced design toggle-style brackets will also be provided, to adjust and hold the fixture against the drywall ceiling from the top. When linking to another fixture or corner fixture module call us or send a copy of your plan along with your PO and flanges will be removed on those end that needs to make a seamless connection.
OPT-SCX-MIF-L	This is a L Module option.
OPT-SCX-MIF-T	This is a T Module option.
OPT-SCX-MIF-X	This is a X Module option.
OPT-SCX-MIF-IC	This is a Inside Corner Module option.

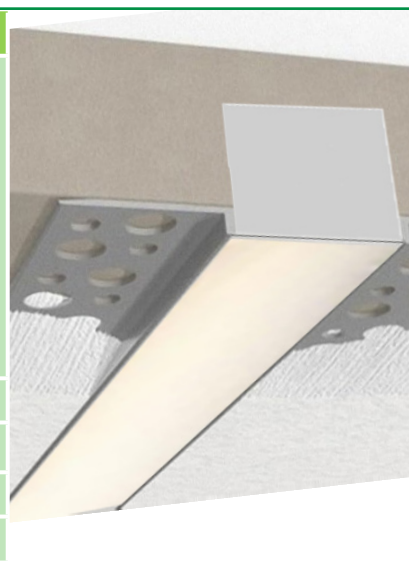

## T-BAR INSTALLATION

Model	DESCRIPTION
OPT-SCX-TBAR-8FT	Add this option and 1/2" wide flanges will be installed on the two long sides of the fixture. The two ends of the fixture will fall onto the T-bar grids and will be supported this way. The T-bar tiles on the two sides of the fixture must be cut to allow for the width of the fixture. The tile will fall onto and be supported by the flanges on both sides of the fixture. If you plan to support the fixture by the grids on three sides and tile on one side, call us or specify on your PO, and flange will be installed only on one side of the fixture. To provide safety and support from the beams above the T-bar ceiling order 10ft or 20ft aircraft suspension kits below.
SCL-GS10	Adjustable 1/16" 10ft suspension kit with loop gripper & toggle ends hold up to 70 lbs load.
SCL-GS20	Adjustable 1/16" 20ft suspension kit with loop gripper & toggle ends hold up to 70 lbs load.
OPT-FWH-63	This is a 6FT 3-Wire Whip option.
OPT-FWH-65	This is a 6FT 5-Wire Whip option.
OPT-FWH-66	This is a 6FT 6-Wire Whip option.



## SURFACE MOUNTING

No additional accessories required.  
Screw and anchor kit provided with each fixture can be used to fasten the fixture directly to the hard surface through the holes on top of the fixture.

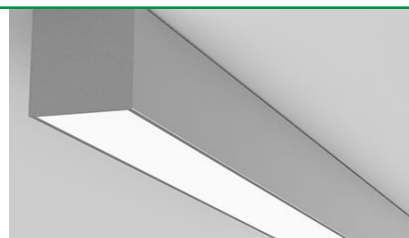

## FACTORY-INSTALLED OPTIONS:

### LOUVER VERSION

Model	DESCRIPTION	LUMENS @ 4000K	SIZE
OPT-SCX-LUV-8FT	This Louver option includes lens inside.	8640LM	8FT



### COLOR OF YOUR CHOICE

Model	DESCRIPTION
OPT-SCX-CLR-8FT	Add this option and specify your desired color on your purchase order or provide a swatch to match. For painted flanged fixture or optional rod, mounting set please also add the relevant option below for each fixture.
OPT-SCX-CLR-FRM	This is a painted flanges option.
OPT-SCX-CLR-RODSET	This is a painted rod set option.

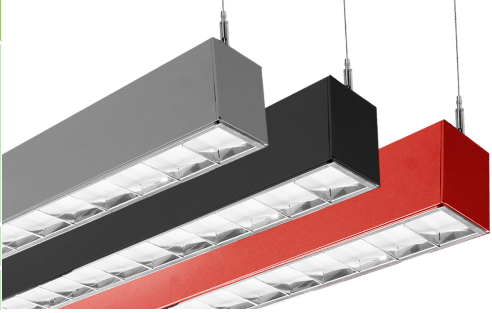

### INDIRECT (UP) LIGHTING

Model	WATTS	LUMENS	COLOR TEMP	SIZE
OPT-SCX-ULM-8FT-32W-30K	32W	3200LM	3000K	8FT
OPT-SCX-ULM-8FT-32W-35K	32W	3296LM	4000K	8FT
OPT-SCX-ULM-8FT-32W-40K	32W	3360LM	5000K	8FT
OPT-SCX-ULM-8FT-32W-50K	32W	3456LM	6000K	8FT
OPT-SCX-ULM-BU	Indirect (up) light with blue color			
OPT-SCX-ULM-GR	Indirect (up) light with green color			



### EMERGENCY BATTERY BACKUP

Model	DESCRIPTION
OPT-EM-CM2INT	This is an option for a 90-minute backup battery installation. If you need to order this series for the fixture, please have your purchase order ready and call us or specify on the order which fixture to install this option and the test button.

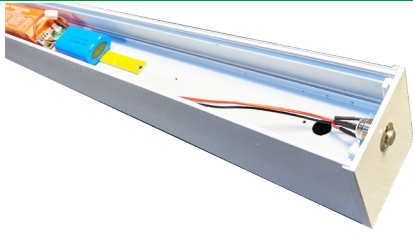

### BI-LEVEL MOTION SENSOR

Model	DESCRIPTION
OPT-SCX-SEN2US	This option installs an advanced motion sensor that will turn the lights on when the area is occupied. When the area is cleared, after a preset hold time of 5 sec or more the lights are dimmed to a standby level of 30% or more. If still no motion is detected, after the standby period, the light is turned off. All setting is programmable with a remote control.
OPT-WEC-3RC	This is an optional remote control for sensor.
OPT-SEN-SCX-2MRLV-5	This is a programmable microwave Bi-Level sensor.
OPT-SEN-2US-DAYLIGHT	It is an ultrasonic Bi-Level Dimming Daylight sensor option for internal installation inside the fixture. (Remote not needed)



# CORNER FIXTURE MODULES:

## Built-in LED Modules

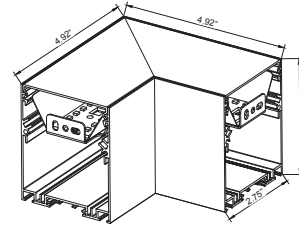
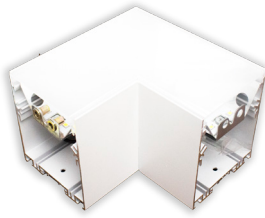

Model	JOINT TYPE	LUMENS	COLOR TEMP	DIMENSION
SCX-L-30K	L	508LM	3000K	4.92" X 4.92" X 3.35" X 2.75"
SCX-L-35K	L	575LM	3500K	4.92" X 4.92" X 3.35" X 2.75"
SCX-L-40K	L	616LM	4000K	4.92" X 4.92" X 3.35" X 2.75"
SCX-L-50K	L	660LM	5000K	4.92" X 4.92" X 3.35" X 2.75"

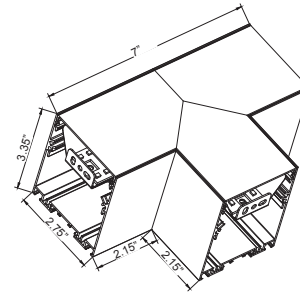

Model	JOINT TYPE	LUMENS	COLOR TEMP	DIMENSION
SCX-T-30K	T	629LM	3000K	7" X 3.35" X 2.75" X 2.15" X 2.15"
SCX-T-35K	T	726LM	3500K	7" X 3.35" X 2.75" X 2.15" X 2.15"
SCX-T-40K	T	787LM	4000K	7" X 3.35" X 2.75" X 2.15" X 2.15"
SCX-T-50K	T	854LM	5000K	7" X 3.35" X 2.75" X 2.15" X 2.15"

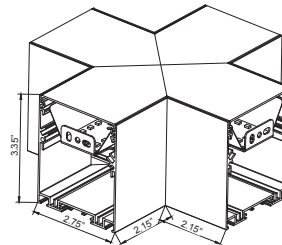
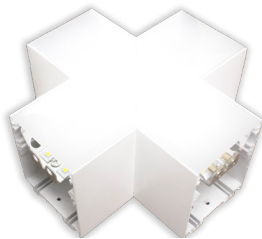

Model	JOINT TYPE	LUMENS	COLOR TEMP	DIMENSION
SCX-X-30K	X	733LM	3000K	3.35" X 2.75" X 2.15" X 2.15"
SCX-X-35K	X	863LM	3500K	3.35" X 2.75" X 2.15" X 2.15"
SCX-X-40K	X	944LM	4000K	3.35" X 2.75" X 2.15" X 2.15"
SCX-X-50K	X	1037LM	5000K	3.35" X 2.75" X 2.15" X 2.15"



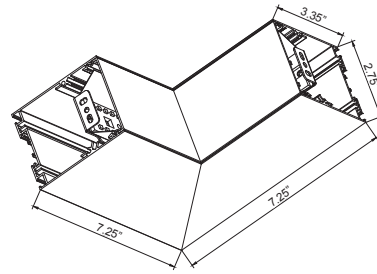

Model	JOINT TYPE	LUMENS	COLOR TEMP	DIMENSION
SCX-IC-30K	INSIDE CORNER	629LM	3000K	7.25" X 7.25" X 3.35" X 2.75"
SCX-IC-35K	INSIDE CORNER	726LM	3500K	7.25" X 7.25" X 3.35" X 2.75"
SCX-IC-40K	INSIDE CORNER	787LM	4000K	7.25" X 7.25" X 3.35" X 2.75"
SCX-IC-50K	INSIDE CORNER	854LM	5000K	7.25" X 7.25" X 3.35" X 2.75"

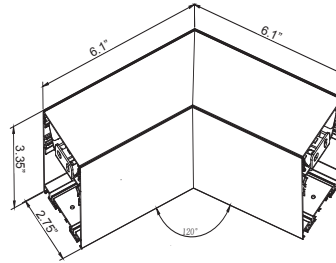

Model	JOINT TYPE	LUMENS	COLOR TEMP	DIMENSION
SCX-C120-30K	120° CORNER	508LM	3000K	6.1" X 6.1" X 3.35" X 2.75"
SCX-C120-35K	120° CORNER	575LM	3500K	6.1" X 6.1" X 3.35" X 2.75"
SCX-C120-40K	120° CORNER	616LM	4000K	6.1" X 6.1" X 3.35" X 2.75"
SCX-C120-50K	120° CORNER	660LM	5000K	6.1" X 6.1" X 3.35" X 2.75"

### Example:

- SCX-8FT-80W-MCT4-D** (For SCX 80W MCT4 fixture 120-277V)
- SCX-8FT-80W-MCT4-D** (For SCX 80W MCT4 fixture 120-277V)  
**SCL-CS** (Adjustable 6ft 1/16" Aircraft Cable Suspension Kit with Canopy for Ceiling or T-Bar)  
**OPT-HBC-125BS-WH** (10FT, 15A, 125V, 18/3 STR, WHT)

