

JOB NAME: _____

DATE: _____

TYPE: _____

DIMENSIONS:

24"(L) x 48"(H) x 2.75"(D)

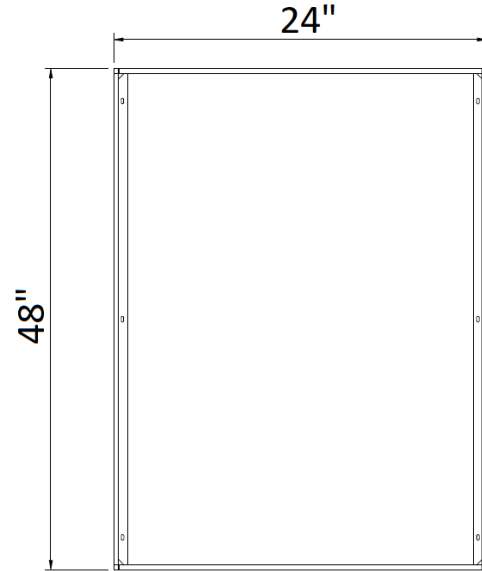
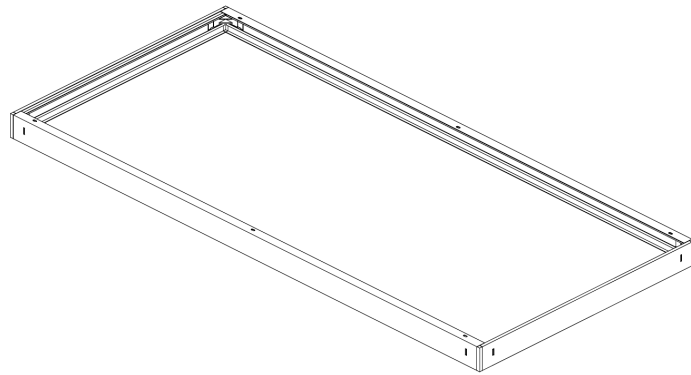

LPNG-SRFC-2X4

SURFACE MOUNTING KIT FOR 2X4 PANEL

- Surface mounting kit for 2X4 panel
- Material: Aluminum
- Finish: White

WARRANTY: 5 years

