

JOB NAME: _____

DATE: _____

TYPE: _____

DIMENSIONS:

24.21"(L) x 13.77"(W) x 1.96"(H)

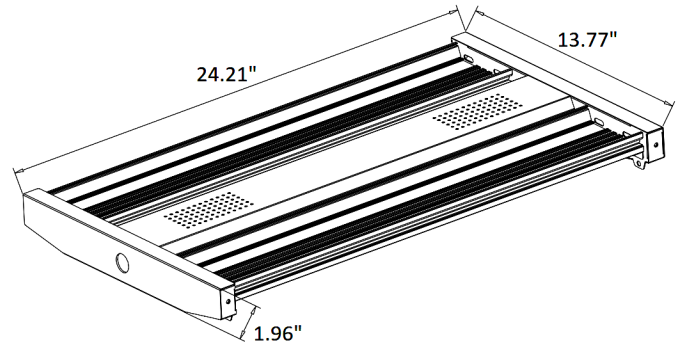

LLHB4-100W-40K-D LLHB4-100W-50K-D

4TH GENERATION OF LED LINEAR HIGH BAYS

Ideal for one-for-one replacement of conventional lighting systems such as HID and fluorescent. Applications include manufacturing warehousing and other large indoor spaces with mounting heights from 10 ft. to 40 ft. Fixture can be Surface mounted also.

ELECTRICAL SPECIFICATIONS:

- Voltage: 120~277VAC/50~60 Hz
- Wattage: 100W
- Power factor: >0.95
- Efficacy: 155LM/W

HOUSING SPECIFICATIONS:

- Surge protector
- Extruded aluminum housing
- Individual, pure aluminum heat sinks
- Operating temperature: -4°F ~ 131°F
- Suitable for damp Locations

CERTIFICATIONS: UL, DLC



WARRANTY: 5 years

MODEL	WATTS	VOLTAGE	LUMENS	COLOR TEMP
LLHB4-100W-40K-D	100W	100~277VAC	15500LM	4000K
LLHB4-100W-50K-D	100W	100~277VAC	15500LM	5000K

OPTIONAL ACCESSORIES:



SCL-GSY10
SCL-GSY20



LLHB4-100W-WG
(Fixture Show with
LLHB4-100W-WG)

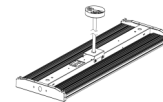

LLHB4-RODKIT
(Fixture Show with
LLHB4-RODKIT)



LLHB4-SMK
(Fixture Show with
LLHB4-SMK)

MODEL	DESCRIPTION
SCL-GSY10	HEAVY-DUTY ADJUSTABLE 10 FT. 1/16" SUSPENSION KIT WITH Y-CONNECTOR & LOOP GRIPPER & HOOKS
SCL-GSY20	HEAVY-DUTY ADJUSTABLE 20 FT. 1/16" SUSPENSION KIT WITH Y-CONNECTOR & LOOP GRIPPER & HOOKS
LLHB4-100W-WG	Wire guard for LLHB4-100W
LLHB4-RODKIT	Optional Rod Kit, 3-1/4" DIA. X 40" H
LLHB4-SMK	Optional Surface Mounting Kit

LIGHTING SPECIFICATIONS:

- Dimming: 0~10 Dimmable
- Lens: Polycarbonate Lens
- Total lumens: 15500LM (Per industry standards, Lumens are reported without frosted lens)
- Color temperature: 4000K /5000K
- Color rendering index: >80
- Wide Beam angle



WESTGATE

THE FUTURE IS HERE...AND IT'S QUITE BRIGHT!

ECLIPTIC  **SERIES**
INDUSTRIAL LIGHTING

JOB NAME: _____

DATE: _____

TYPE: _____

LLHB4-100W-40K-D LLHB4-100W-50K-D

4TH GENERATION OF LED LINEAR HIGH BAYS



FACTORY-INSTALLED OPTIONAL ACCESSORIES:

MODEL	DESCRIPTION
OPT-EM-HB4EXT	Emergency Backup for LLHB4-100W
OPT-LLHB-OC-BL	Motion Sensor For LLHB4-100W

MODEL	WATTS	VOLTAGE	LUMENS	COLOR TEMP
LLHB4-100W-40K-D	100W	100~277VAC	15500LM	4000K
LLHB4-100W-50K-D	100W	100~277VAC	15500LM	5000K

